

revital 

The Sample First Company<sup>®</sup>

# OUR VISION

To **Connect** through our  
sample first approach

To **Accomplish** through our  
world class wellness product

To **Prove** through our self-evident results

To **Simplify** through our  
industry leading technology

To **Sustain** through alignment in  
everything we say, touch and do

revital U is  
**a direct to consumer  
health & wellness company.**



Science



Technology



Social Media



Relationships



**Evolution** is reinventing  
industries right before our eyes.

The health & wellness industry is experiencing  
a spike like never before.

# Our **Products**

Our idea was

**Products**, that can be  
used day & night, and  
sampled first.

# 11 Bio-Optimized Ingredients

- APPETITE
- ENERGY
- FOCUS

† Ingredients are found in food shown



We have products for day  
and night.

Revitalize your routine with  
our Smart & Sleep lines.





**revital U Smart Products**  
are designed to help:

**Curb your appetite\***

**Boost your energy\***

**Help you stay focused\***

**Uplift your Mood\***

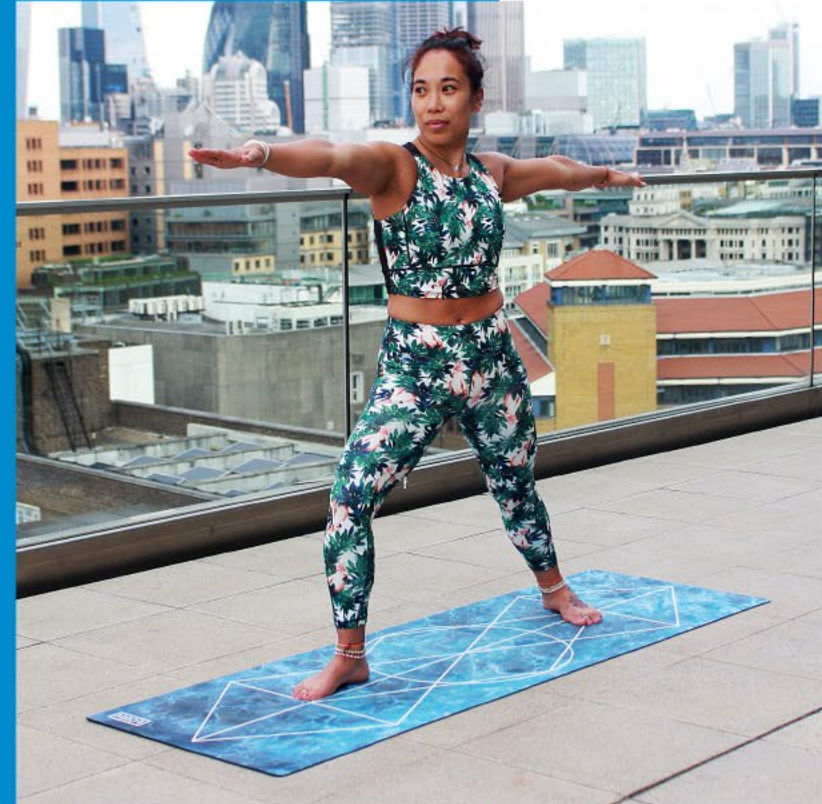

\*These statements have not been evaluated by the Food and Drug Administration. These products are not intended to diagnose, treat, cure or prevent any disease.

# Smart Coffee



**\$1.33-\$1.83** per serving



**One-Time** Purchase

**Monthly** Subscription

**Tub**  
30-servings

\$49.99

\$39.99

**Box**  
30-servings

\$54.99

\$44.99

# Smart Cocoa



**\$1.33-\$1.83** per serving



**One-Time** Purchase

**Monthly** Subscription

**Tub**  
30-servings

\$49.99

\$39.99

**Box**  
30-servings

\$54.99

\$44.99

# Smart Mocha Bundle



15 Smart Coffee Sticks  
15 Smart Cocoa Sticks  
1 Special Edition Revital U Mug

**Box**  
30-servings

**Monthly** Purchase \$49.99

**One-Time** Purchase \$59.99

# Smart Caps



**\$1.33-\$1.66** per serving



**Box**  
30-servings

**One-Time** Purchase **\$49.99**

**Monthly** Subscription **\$39.99**

**revital U Sleep Products**  
are designed to help:

**Promote Peaceful Sleep\***

**Calm your senses\***

**Revitalize you for the  
day that lies ahead\***



\*These statements have not been evaluated by the Food and Drug Administration. These products are not intended to diagnose, treat, cure or prevent any disease.

# Sweet Dreams

**\$44.<sup>99</sup>**

Monthly  
Purchase

**\$54.<sup>99</sup>**

One-Time  
Purchase



# 24 (AM/PM Bundle)



1 Box of Smart Caps  
1 Sweet Dreams Bottle

**Box**  
30-servings

**One-Time** Purchase

**\$89.99**





revital U **Opportunity**



# Linear income

VS.

# Leveraged Residual income

**Linear income** earn from personal efforts.  
One unit of pay.

**Leveraged income** earn from personal  
and team efforts. Multiple units of pay.

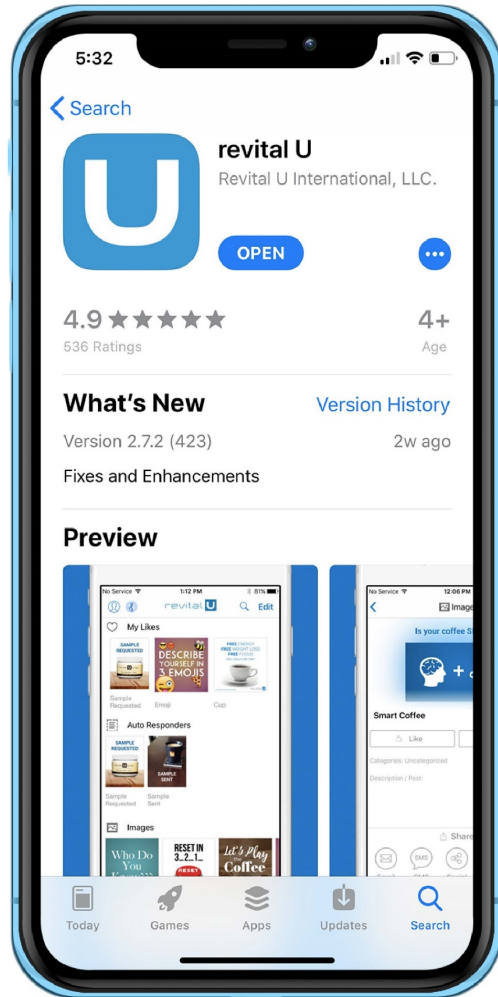

# Mobile APP Download



Download on the  
**App Store**



GET IT ON  
**Google Play**

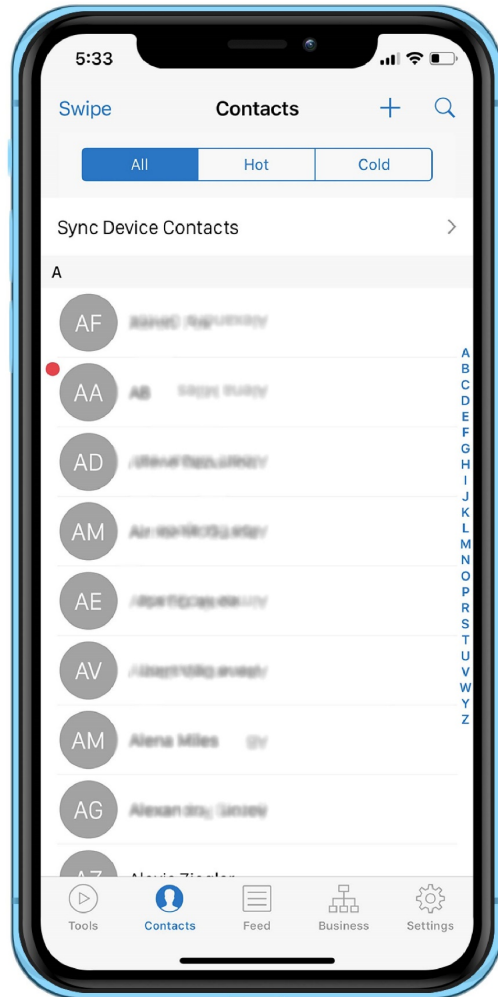

**Mobile APP**  
Add your  
contacts

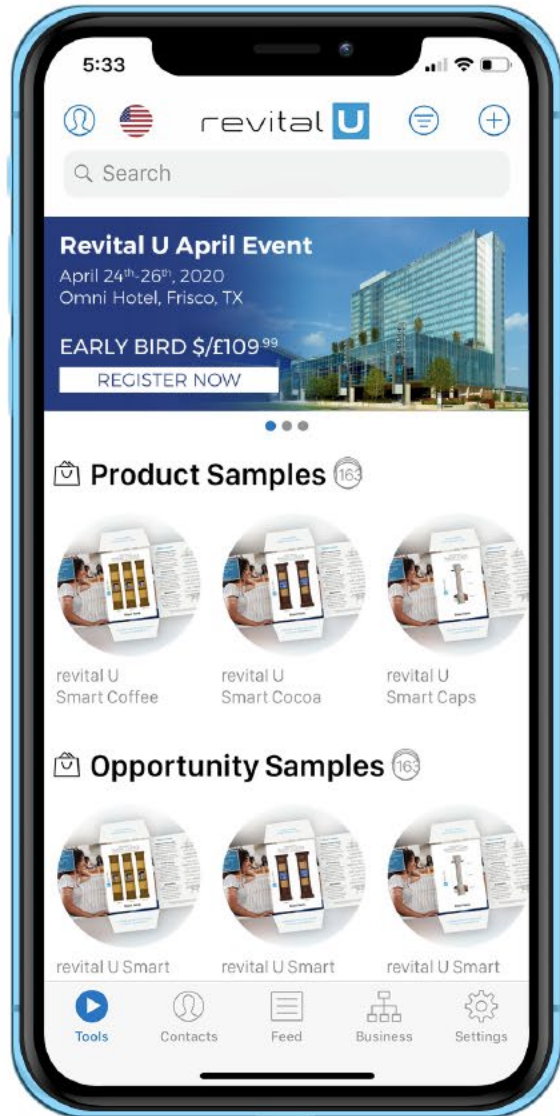

# Mobile APP

Product Samples =  
Customers

Opportunity Samples =  
Influencers

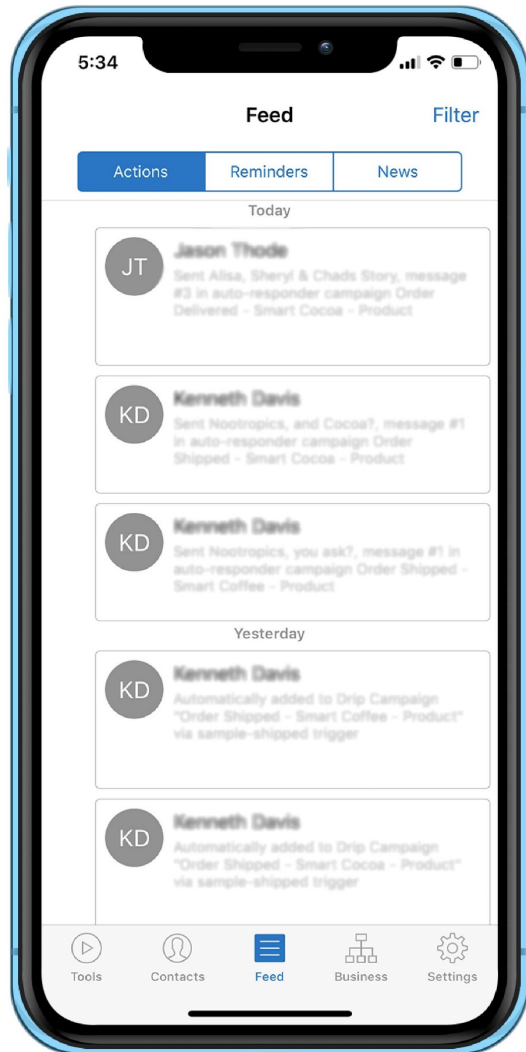

# Mobile APP Automated Follow-Up & Notifications

# Virtual Business Platform

- **Full Access to Back Office Tools and Features:** Genealogy Viewer  
Holding Tank  
Social Media Sharables  
Business Progress Page  
And Much More...!
- **5 Digital Credits for first 3 Subscription Payments**
- **Customer Club Access**  
(includes enhanced Travel and discounted Identify Theft)
- **Personalized Long Code (SMS)**  
Hold My Spot & Customer Sampling Features
- **1 Customer Point**  
(Counts for Rank Advancement and Maintenance)

**\$29.99**  
Monthly

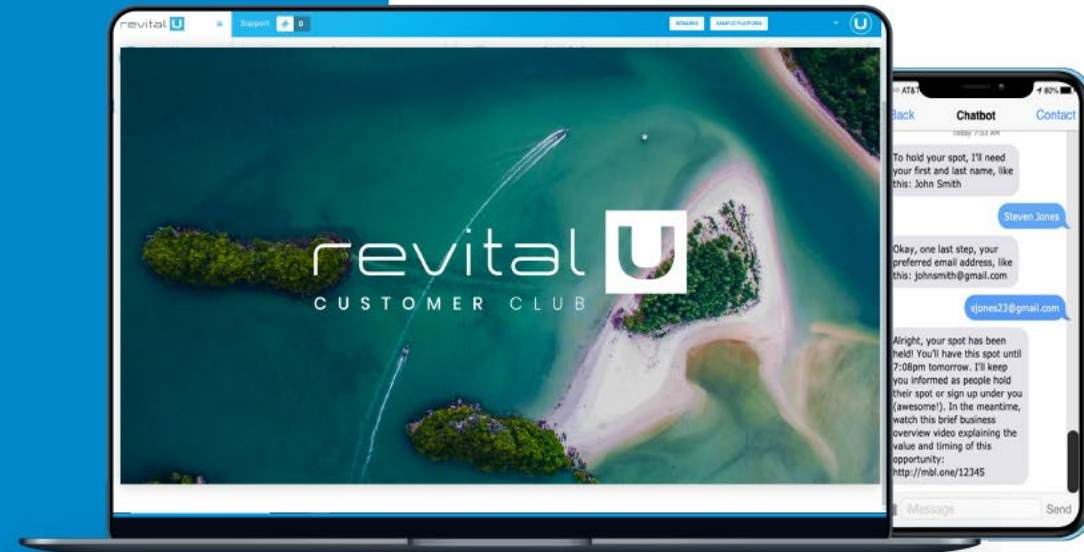

OPTIONAL

# Personal Delivery Pack

\$99.99

retail value  
\$369.99

- 1 Tub of Smart Cocoa
- 2 Smart Caps
- 1 Smart Coffee Tub
- 1 Smart Coffee Box
- 1 Sweet Dreams Bottle
- 1 Smart Caps Brochure Pack
- 2 Sweet Dreams Brochure Packs
- 1 Smart Coffee





# Customer Booklet

This Revital U Customer Booklet has been designed to give your prospective customers information on our business history, our sample first concept and in depth details on the products we offer. Use these booklets as a tool to attract prospective customers AND Brand Influencers.

**1 Pack** of 10

\$12.99

**2 Packs** of 10

\$19.98

**3 Packs** of 10

\$26.97



# Personal Customer Commissions

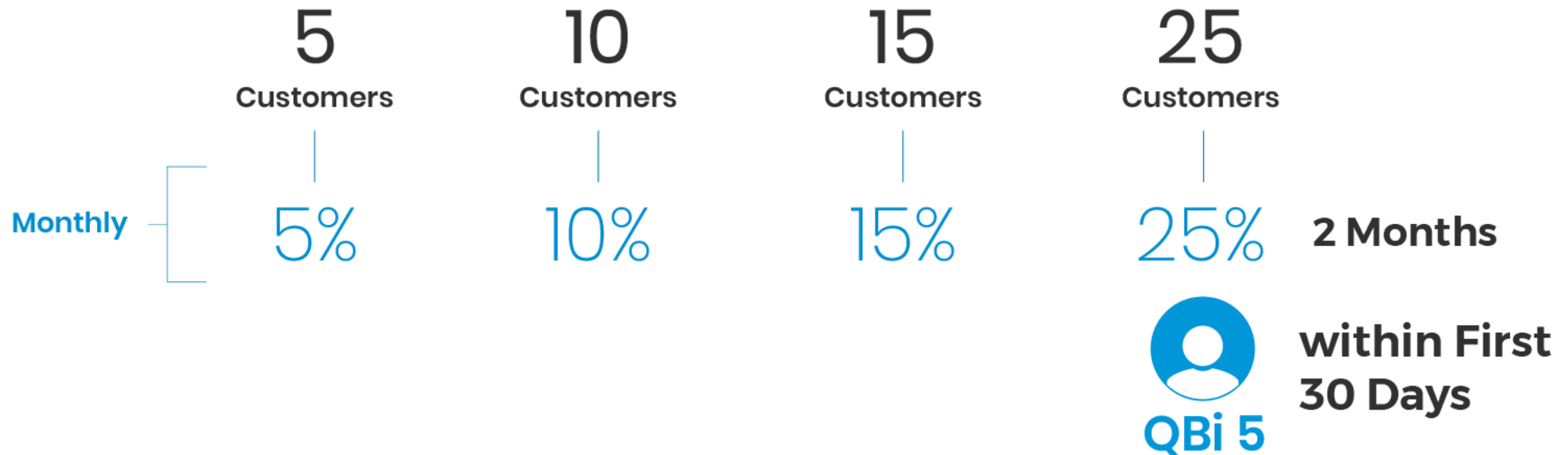
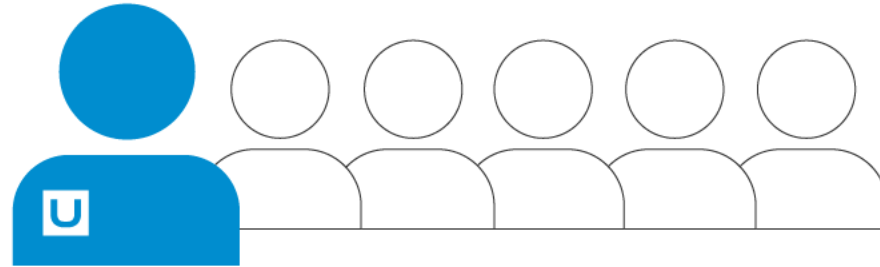

# Team Customer Commissions

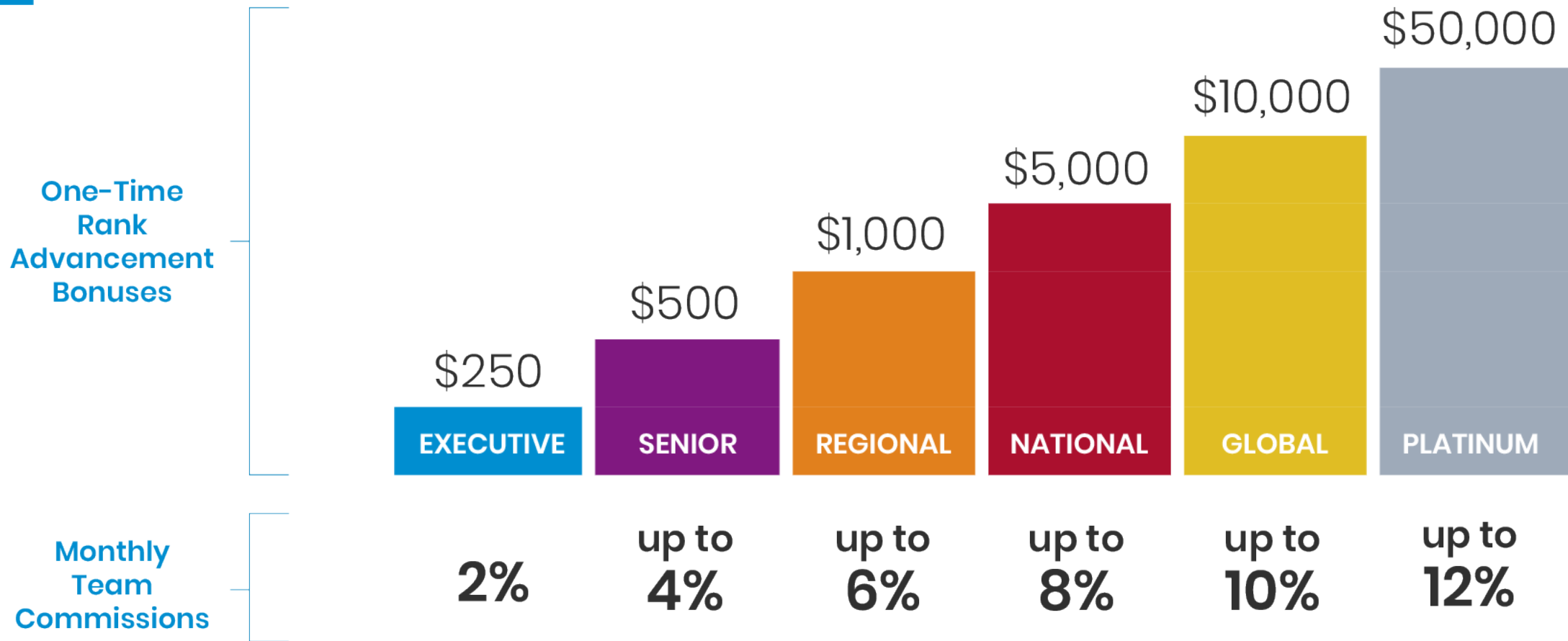

Please see document in your U Office for important additional details and requirements.

# February **Promotions**



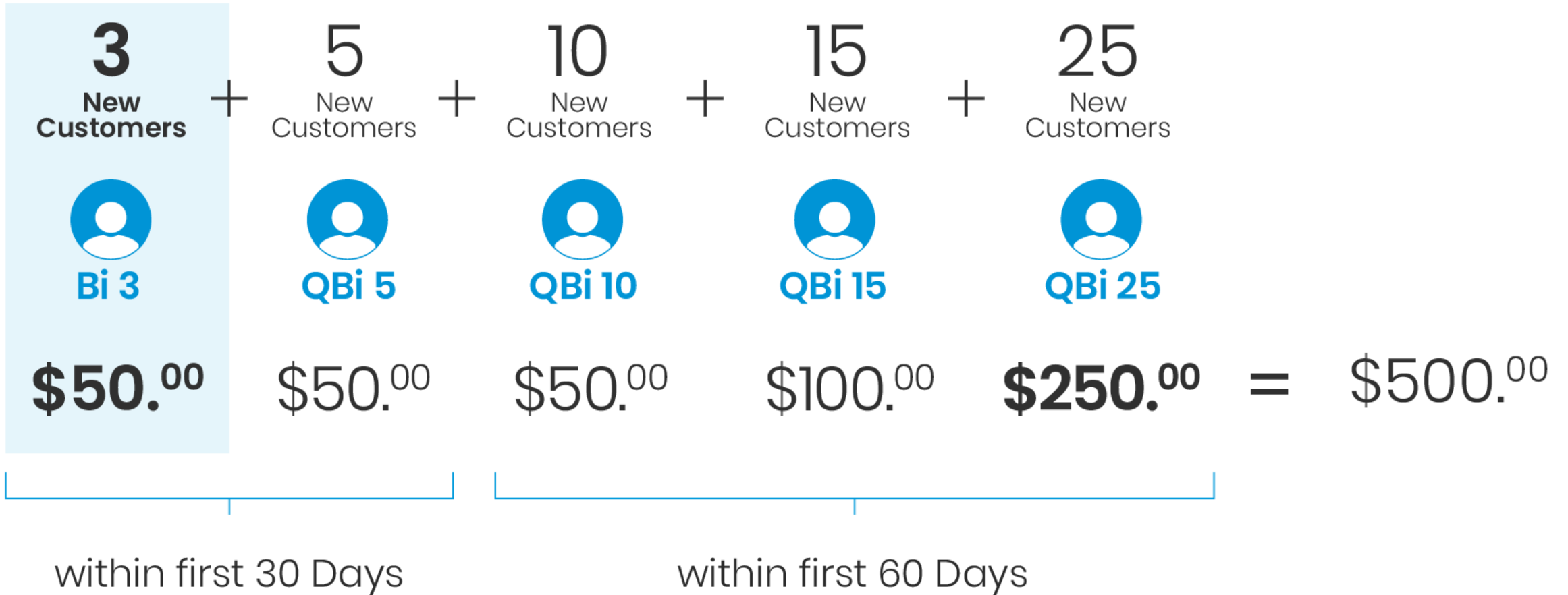

# New Customer **Fast-Start Bonus**

New Influencers  
with App. date of  
2/1<sup>st</sup> through 2/29<sup>th</sup>



# New Customer **Fast-Start Bonus**

New Influencers  
with App. date of  
2/1<sup>st</sup> through 2/29<sup>th</sup>

	3 New Customers	+	5 New Customers	+	10 New Customers	+	15 New Customers	+	25 New Customers		
											
	<b>Bi 3</b>		<b>QBi 5</b>		<b>QBi 10</b>		<b>QBi 15</b>		<b>QBi 25</b>		
New Bi	<b>\$50.00</b>		\$50.00		\$50.00		\$100.00		<b>\$250.00</b>	=	\$500.00
Enroller	<b>\$50.00</b>		\$50.00		\$50.00		\$100.00		<b>\$250.00</b>	=	\$500.00
	within first 30 Days					within first 60 Days					

# EBi Rank Advancement **Fast-Start Bonus**

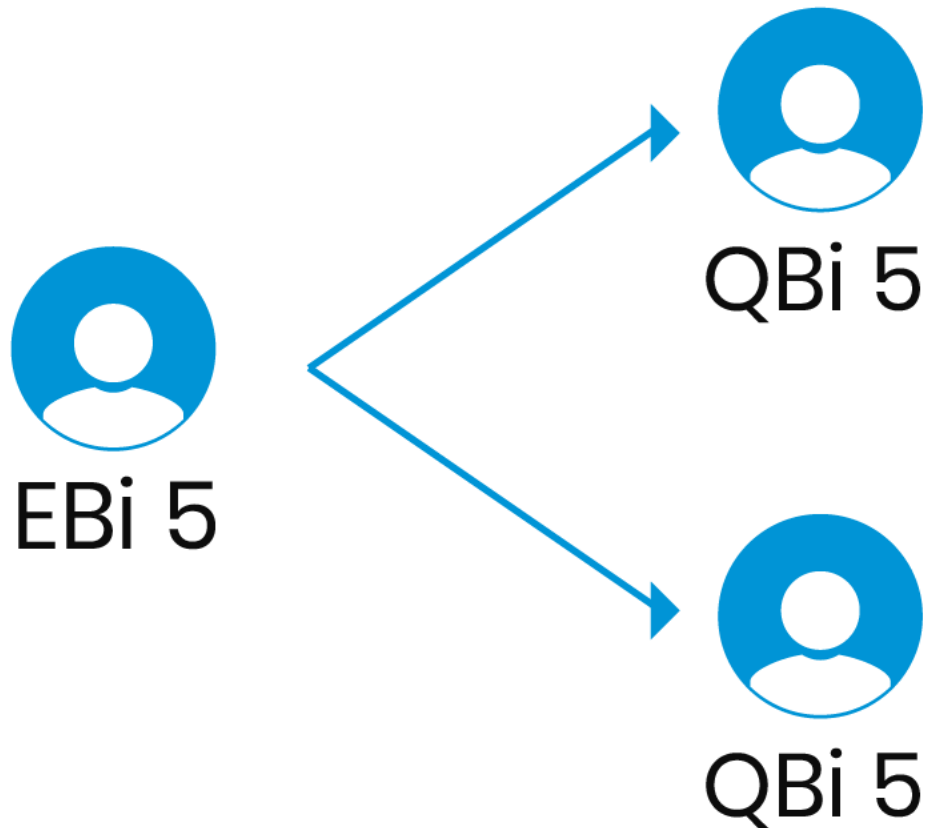

NEW Bi  \$500.00  
EBi 5

ENROLLER  \$500.00

**Within 60 Days**

New Influencers with App. date of  
February 1<sup>st</sup> through February 29<sup>th</sup>

# Ebi Rank Advancement and New Customer Fast-Start Bonus

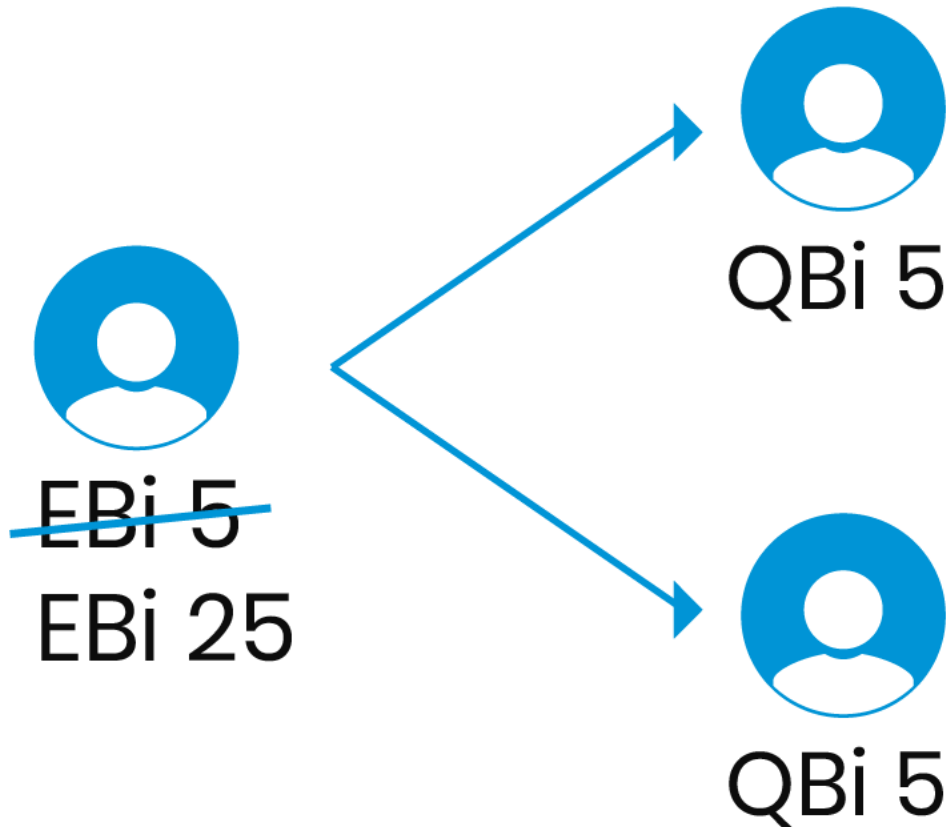

NEW Bi  ~~\$500.00~~  
EBi 25 **\$1,000.00**

ENROLLER  ~~\$500.00~~  
**\$1,000.00**

**Within 60 Days**

New Influencers with App. date of  
February 1<sup>st</sup> through February 29<sup>th</sup>



# Team Achievement Bonuses

## February Promotion

**PAID WEEKLY**

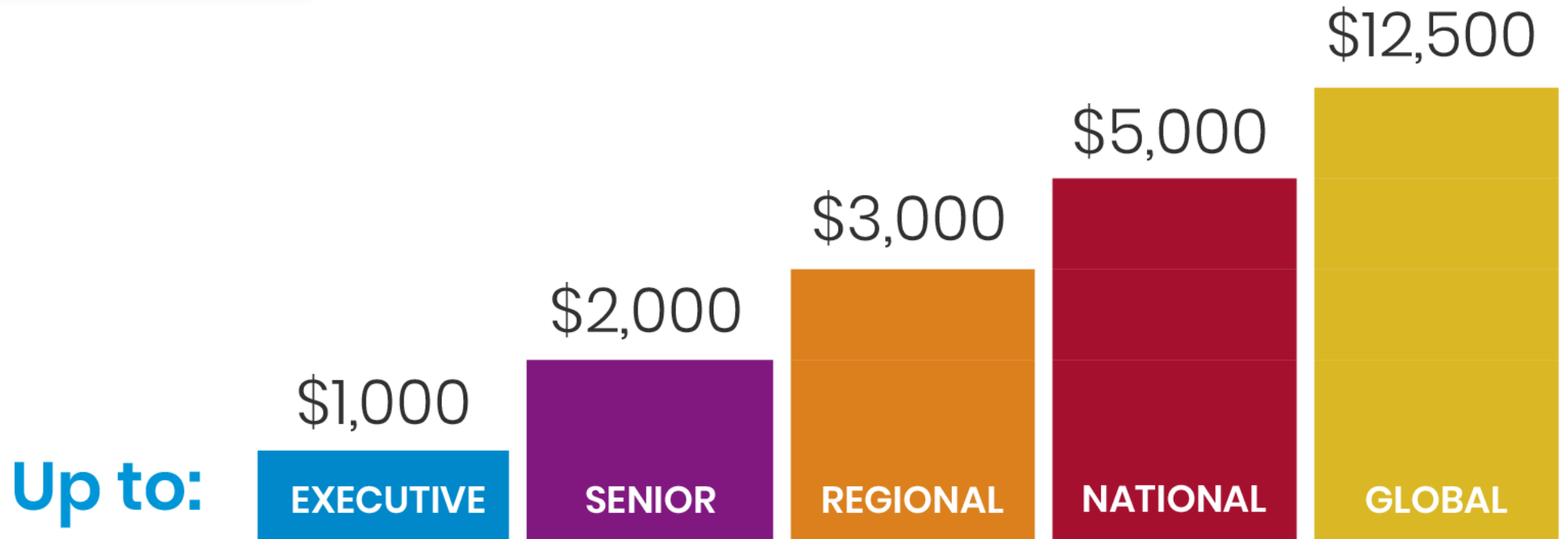

Disclaimer: Influencers purchased by a 3rd party method of payment will not be included.

# Promotional Rank Advancements

## February 1<sup>st</sup> through February 29<sup>th</sup>

February  
Promotion

### LIMITED TIME OPPORTUNITY

	QBi	EBi	SBi	RBi	NBi	GBi	PBi
Personally Enrolled Customers	5	5	10	10	10	10	10
Personally Enrolled Legs		2 QBis	3 Legs	3 Legs	4 Legs	4 Legs	6 Legs
Customer Count Per Leg			25 Per Leg	<b>100 Per Leg</b>	<b>200 Per Leg</b>	<b>500 Per Leg</b>	5,000 Per Leg

# Team Achievement Bonuses

## February Promotion

February 1<sup>st</sup> through February 29<sup>th</sup>

New Brand Influencers  
with 3 Customers =  
**1 TAB Point**

New Bis with 3 Customers  
who also purchased  
a Personal Delivery Pack =  
**1 TAB Point**



# Revital U April Event

April 24<sup>th</sup>-26<sup>th</sup>, 2020

Omni Hotel, Frisco, TX

EARLY BIRD \$109.<sup>99</sup>

REGISTER NOW



revital 

The Sample First Company<sup>®</sup>